



Product Specification

产 品 规 格 书

Product Name: LED Grow Light
产品名称: LED 植物灯

Product P/N: OH-GL-014
产品名称: OH-GL-014

Product Size 产品尺寸	540*110*52mm
-----------------------------	--------------

Approval 客户确认:	
Data 日期:	

Prepared by 制作人	Checked by 审核人	Approved by 审批人
Name 姓名: NS WANG	Name 姓名: <i>[Signature]</i>	Name 姓名: <i>[Signature]</i>
Date 日期: 2016-12-20	Date 日期: <i>2016-12-20</i>	Date 日期: <i>24/12-2016</i>
Dept. 部门: 工程部	Dept. 部门: <i>工程部</i>	Dept. 部门:

Updated version number 更新的版本号	
---	--

Ohmax (Asia) Limited

Tel: 00852-2432 2316 Fax: 00852-2436 5097

Address: Unit 4-6,12/F, Block B,Vigor Industrial Bldg.,14-20 Cheung Tat Road,Tsing Yi, N.T. Hong Kong

Shenzhen Ohmax Optoelectronic Lighting Co., Ltd.

Tel:86-755-2845 5703 Fax: 86-755-2752 4841

No.132,Fuxing Street,Hehua Community,Pinghu Subdistrict,Longgang District,Shenzhen,China

1. **Product**
产品
 - 1.1 **Product photo**
产品图片
 - 1.2 **Product Definition**
产品定义
2. **Product features**
产品应用特色
3. **Product Properties**
产品技术参数
 - 3.1 **Product working circuit schematic diagram**
产品工作原理图
 - 3.2 **Product basic working technical data**
产品基本工作参数
 - 3.3 **PPFD Measuring Value**
光量子通量密度实测数据
 - 3.4 **Product photoelectrical testing data**
产品光电参数测试数据
 - 3.5 **Product illumination testing data**
产品照度测试参数
4. **Product Main Material**
产品主要材料及关键配件
 - 4.1 **Driver**
电源
 - 4.2 **LEDs**
灯珠
 - 4.3 **Heat dissipation**
散热
5. **Product Size & Package**
产品尺寸与包装
 - 5.1 **Product size illustration**
产品尺寸图示
 - 5.2 **Product packing info**
产品包装尺寸
 - 5.3 **Product packing illustration**
产品包装图示
 - 5.4 **Carton label**
纸箱标签
6. **Product Installment illustration**
产品安装图示
7. **QA & Safety Standard**
QA 及安全标准
 - 7.1 **Quality control per ISO9001 -2008 Standard**
质量控制依据 ISO9001 - 2008 标准
 - 7.2 **Quality controlling items**
质量控制项目
 - 7.3 **Product safety certificates**
产品质量安全证书
 - 7.4 **Product warranty statement**
产品质保声明
8. **Product Usage Attention Items**
产品使用注意事项

1. Product

产品

1.1 Product photo

产品图片



1.2 Product Definition

产品定义

LED grow light belongs to new generation grow and assistant grow light for plants. The big difference compared with traditional grow light, whether it is HPS or fluorescent or other kinds, that is LED grow light can provide plants special requirement for different light wavelength and light intensity in their different grow phases to maximize the satisfaction for plant light necessity

LED 植物灯为新一代的植物生长助长灯，其与传统植物生长灯的最大差别在于能根据不同植物在不同的生长过程对光波的特殊要求，量身定做提供植物需要的光波及光强，从而实现最大程度满足植物生长对光的要求

2. Product features

产品应用特色

- 1w high power LEDs
用 1w 大功率灯珠
- The lamp is suitable for lighting the plants growing on the grow rack in large scale and for family plant growth
既适合在植物生长架大规模使用，也可用于家庭种植
- **Better heating dissipation, better life span**
更好的散热处理， 更好的寿命

3. Product Properties

产品技术参数

3.1 Product working circuit schematic diagram

产品工作原理图

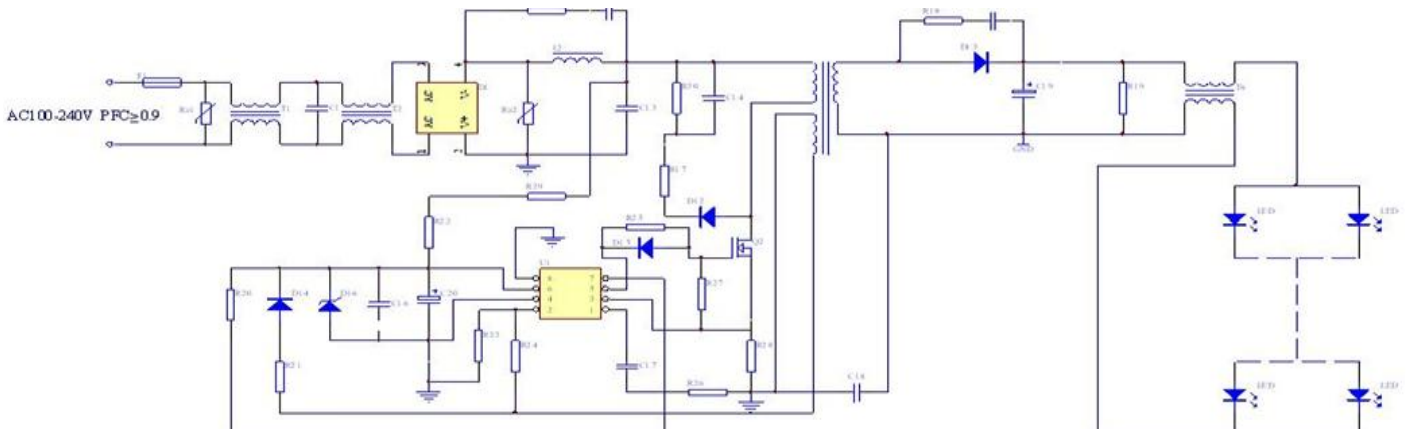

3.2 Product basic working technical data
产品基本工作参数

Power 功率	Real consumption 实际功耗	Input voltage 输入电压	Working Frequency 工作频率	LEDs 灯珠	
90W	94.54W	AC100-240V	50/60HZ	1W High power LEDs	
Flux 光通量	PF 功率因素	Type of LENS 灯罩	Color Ratio 光波比	Fe 幅射通量	Life Span 寿命
9010.3 lm	≥0.90	钢化玻璃	全白	26.803	50,000 H
PAR W/m ² 光合有效辐射		PPFD umol/m ² · s 光量子通量密度	Main wavelength 主要波长	CCT 色温	
26.213		0.2m:176	594nm	4035k	

3.3 PPFD Measuring Value
光量子通量密度实测数据

Length 距离	PPFD Value PPFD 值 (Umol/m ² · S)
0.2m	396 Umol/m ² · S
0.3m	358 Umol/m ² · S
0.5m	237 Umol/m ² · S
0.6m	175 Umol/m ² · S
1.0m	68 Umol/m ² · S
1.5m	31 Umol/m ² · S
2.0m	19 Umol/m ² · S

3.4 Product photoelectrical testing data
产品光电参数测试数据

➤ Photoelectrical testing data by voltage setting 220V
输入电压为 220V 时产品的光电测试参数

样品名称	:	测试日期	:	2016-08-31 10:50:42
样品型号	:	样品状态	:	
样品编号	:	测试仪器	:	HaasSuite(EVERFINE)
制造厂商	:	测试人员	:	FANG LI
		审核人员	:	damin
测试条件				
环境温度	:	环境湿度	:	65.0%
测试范围	:	峰值IP	:	51318 (78%)
测量模式	:	积分时间	:	113 ms
		灵敏度	:	低

光谱参数

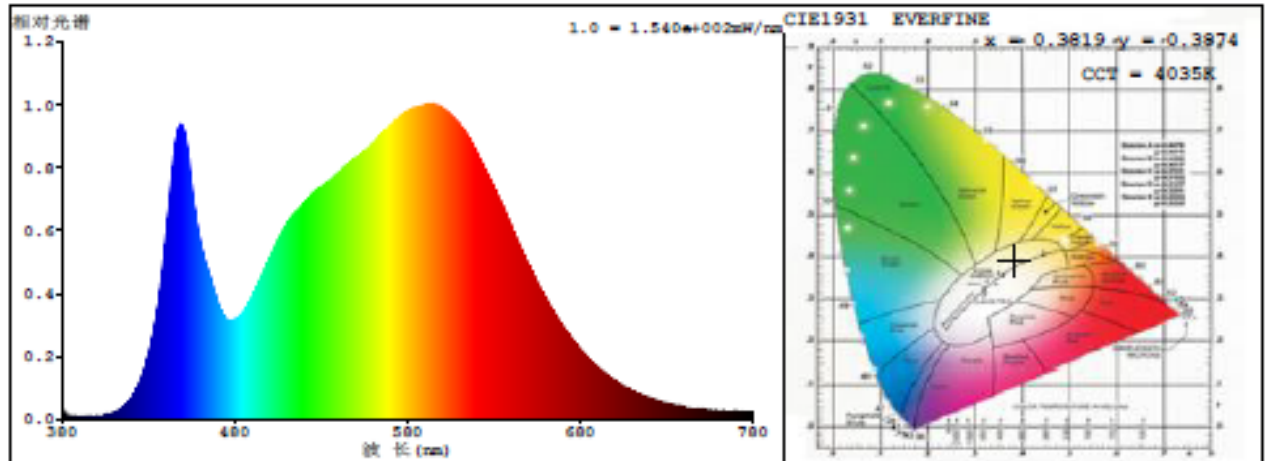

光谱分布

CIE1931色品图

CIE颜色参数

色品坐标: $x = 0.3819, y = 0.3874 / u' = 0.2219, v' = 0.5064$ (duv=4.49e-03)

相关色温:CCT=4035K 主波长: $\lambda_d=576.7\text{nm}$ 色纯度:Purity=30.9%

峰值波长: $\lambda_p=594\text{nm}$ 半峰带宽:FWHM=149.3nm 色比:R=17.7% G=78.8% B=3.6%

显色指数: Ra = 81.6

R1 =79 R2 =87 R3 =95 R4 =81 R5 =79 R6 =83 R7 =86

R8 =62 R9 =0 R10=71 R11=79 R12=62 R13=81 R14=97 R15=72

分级:OUT 白光分类:ANSI_4000K

光度&辐射度参数

光通量 $\Phi = 9010.3 \text{ lm}$ 光效: 95.31 lm/W 辐射通量 $\Phi_e = 26.803 \text{ W}$ 暗视觉:15125 S/P:1.6787

Photons1:2.141e+001 $\mu\text{mol/s}$ (400~500nm) Photons2:4.265e+001 $\mu\text{mol/s}$ (600~700nm)

光合辐射参数: 光量子数: 122.45 $\mu\text{mol/s}$ 光合辐照度:26213mW(400-700nm)

电参数

电压 V = 221.0 V 电流 I = 0.4356 A 功率 P = 94.54 W 功率因数 PF = 0.9818

3.5 Product illumination testing data

产品照度测试参数

Illumination Graph

照度图

A=14230	Lux
B=13270	Lux
C=6110	Lux
D=5100	Lux
E=2790	Lux
F=2189	Lux
G=1410	Lux
H=1035	Lux
I=882	Lux
J=640	Lux
K=615	Lux
L=478	Lux

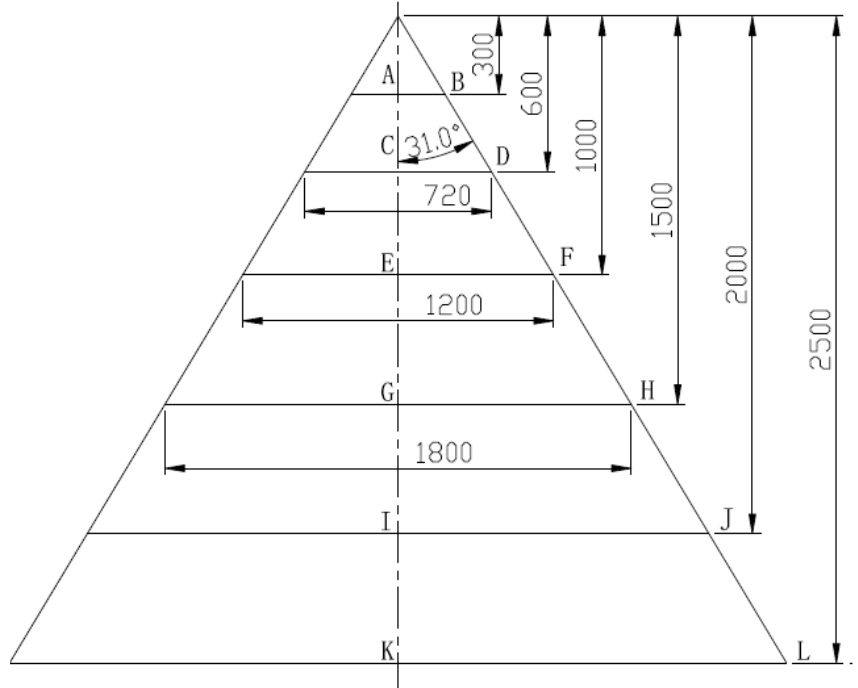

Illumination curve line graph

配光曲线图

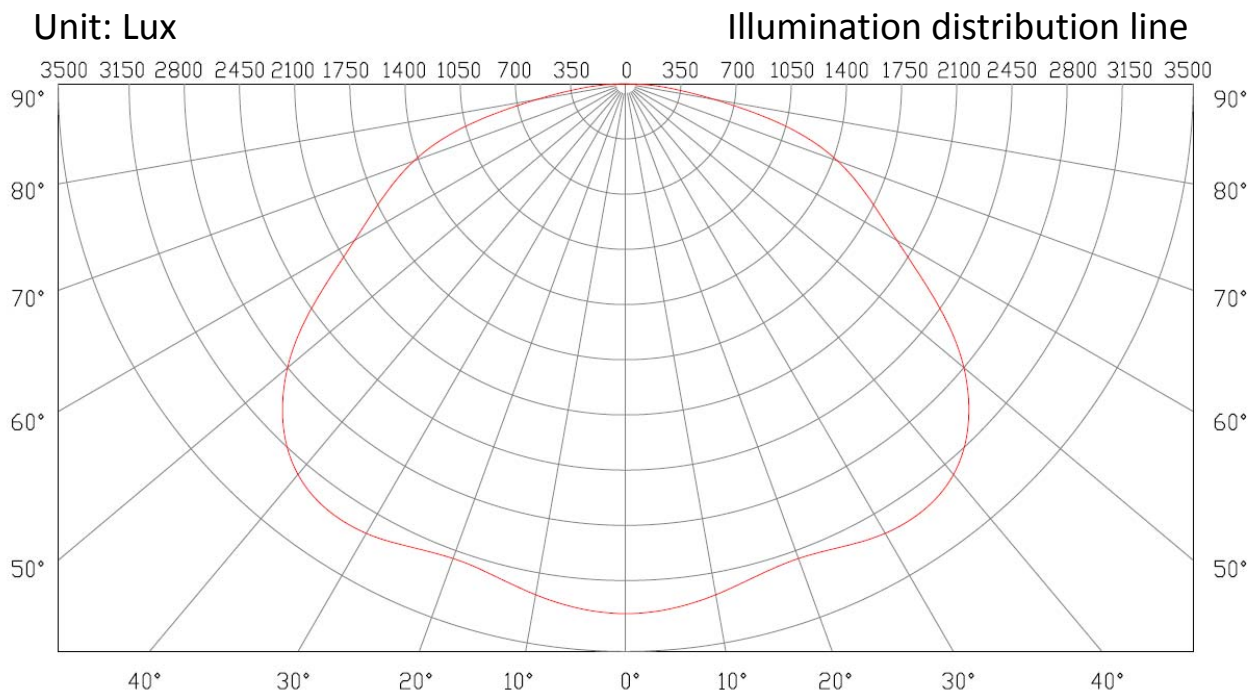

LED GROW LIGHT

4.0 Product Main Material

产品主要材料及关键配件

4.1 Driver

电源

Wide voltage design, AC100V - 240V , 50/60Hz, meet all countries input voltage requirement
宽电压设计, 适合全世界各国家使用

Isolating power supply design, ensure safety in usage

隔离电源设计, 使用安全

Wide voltage design, AC100V - 240V , 50/60Hz, meet all countries input voltage requirement
宽电压设计, 适合全世界各国家使用

Isolating power supply design, ensure safety in usage

隔离电源设计, 使用安全

4.2 LEDs

灯珠

1W LEDs.low lighting attenuation, low energy consumption,
1W 大功率灯珠; 高亮度, 低衰减, 耗能小, 寿命长.抗静电能力强。

符合环保无铅制程产品要求。

4.3 Heat dissipation

散热

High heat conductive Alum-Alloy materials

采用高导热铝合金材料

5.0 Product Size & Package

产品尺寸与包装

5.1 Product size illustration

产品尺寸图示

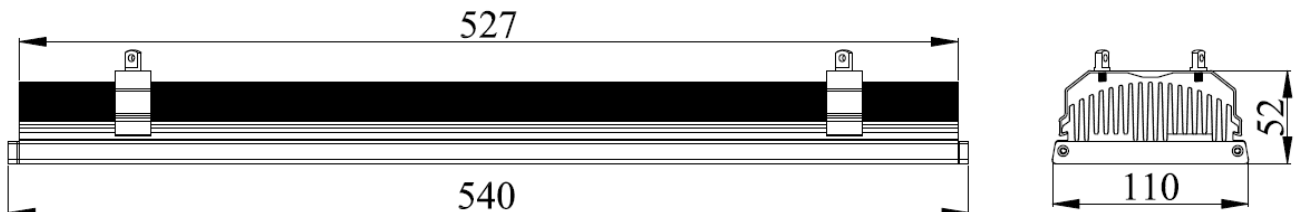

5.2 Product size illustration

产品尺寸图示

Product P/N 产品编号	Product NW 产品净重	Box Size 产品尺寸	Carton Size 纸箱尺寸	GW / Carton 毛重/ 箱	Qty / Carton 产品数量/ 箱
OH-GL-014	2500g	540*110*52mm	590*350*330mm	20.5kg	6 piece

5.3 Product packing illustration
产品包装图示

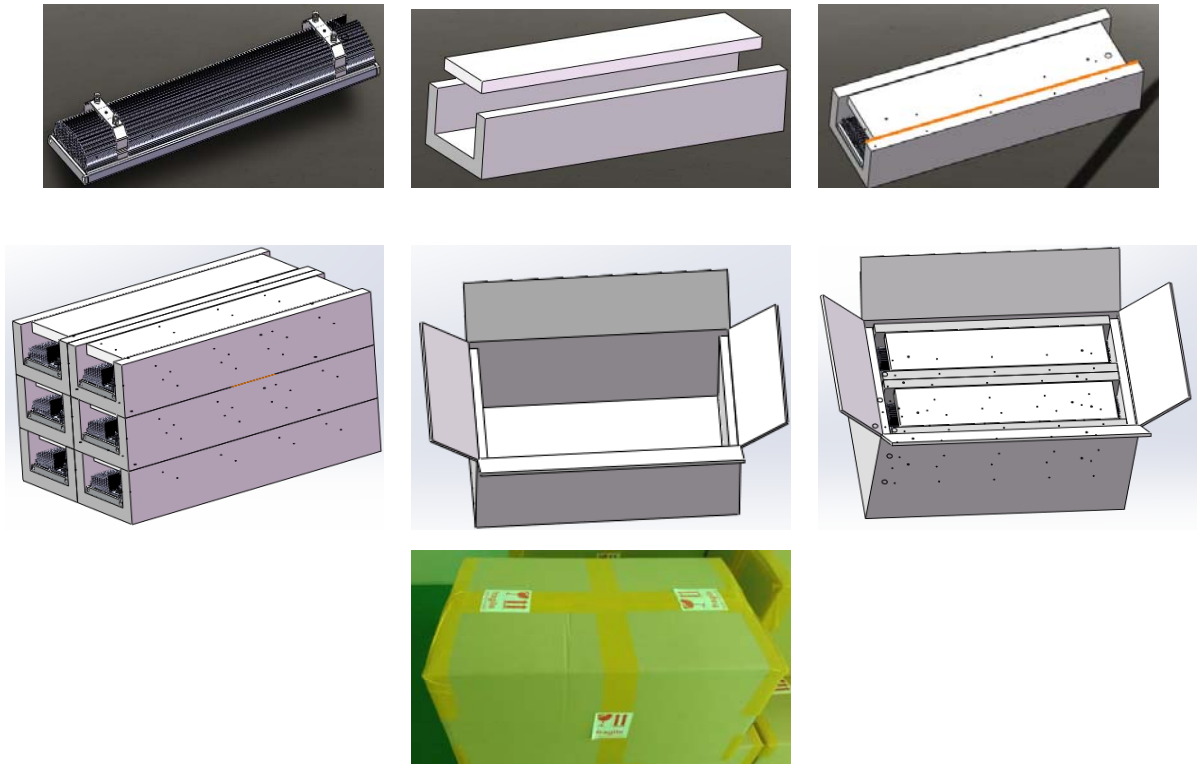

5.4 Carton label
纸箱标签

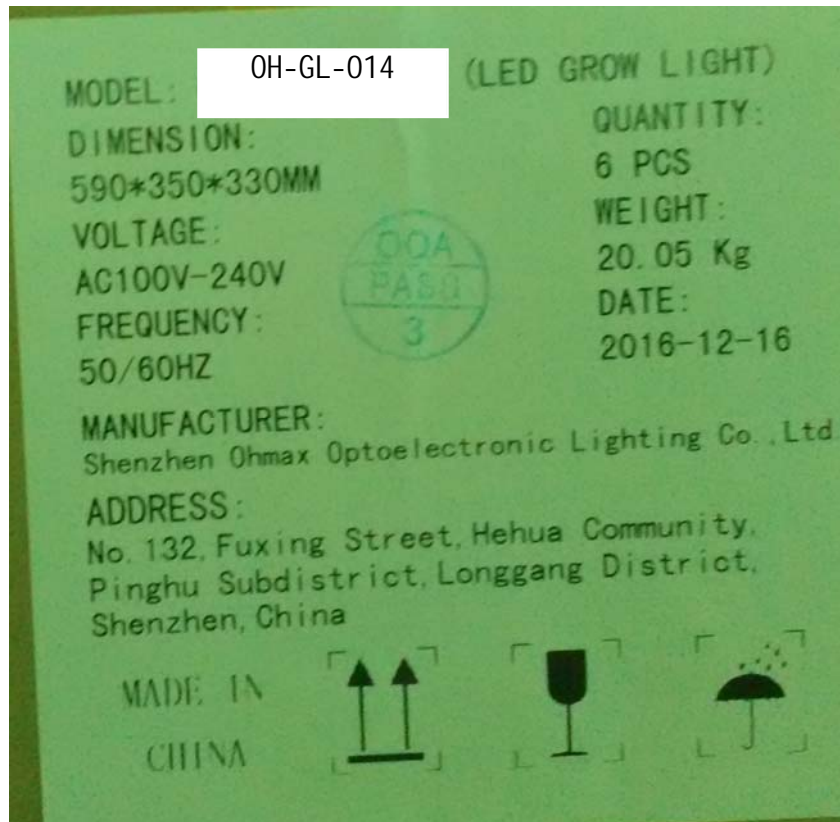

6.0 Product Installment illustration
产品安装图示

- Install the lamp independently
当植物灯安装时

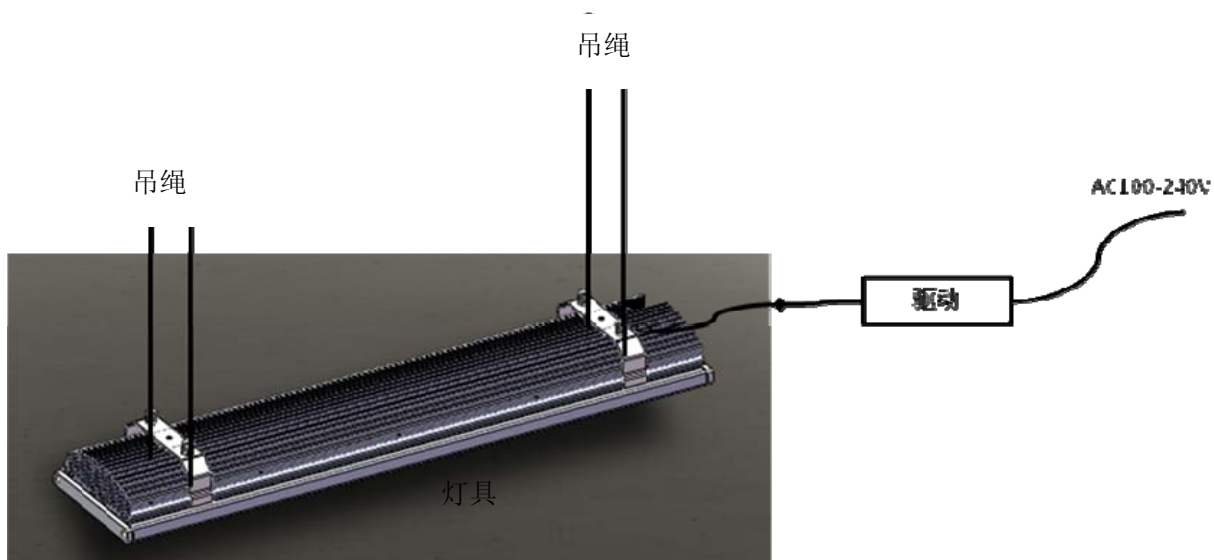

7.0

QA 及安全标准

7.1 Quality control per ISO9001 -2008 Standard

质量控制依据 ISO9001 - 2008 标准

- Product quality control
产品质量控制
 - ✧ Finish product QC inspection standard: MIL-STD-105E C=0
产成品 QC 检验标准: MIL-STD-105E C=0
 - ✧ Production processing QC standard: GB 2829—87 - Periodical checking and sampling procedures
生产过程 QC 检验标准: GB 2829-87 - 定时抽检和打样程序
 - ✧ QC confirm every production step and keep record
QC 记录生产的每个步骤并保留记录
- Raw material & Components quality control
原材料及配件质量控制
 - ✧ Driver: Per MIL-STD-105E C=O
驱动 依据 MIL-STD-105E C=O
 - ✧ LEDs : Per MIL-STD-105E C=O
灯珠 依据 MIL-STD-105E C=O
 - ✧ Heat dissipation: Per MIL-STD-105E C=O
散热 依据 MIL-STD-105E C=O

7.2 Quality controlling items

质量控制项目

- Switching Test: Switch on/off for 10 times with interval time 10 sec.
开关测试 间隔 10 秒种 10 以上开关测试
- Reliability Tests:
可靠性测试

	Conditions 条件
High Temperature Operation Test 高温运行测试	Ta=50°C, 240hrs
Low Temperature Operation Test 低温运行测试	Ta=-20°C, 240hrs
High Temperature Storage Test 高温存放测试	Ta=70°C, 240hrs
Low Temperature Storage Test 低温存放测试	Ta=-30°C, 240hrs
High Temperature and High Humidity Test 高温及高温测试	Ta=40°C, 95%RH, 240hrs

- Aging Test: Default two days or Per customer requirement
老化测试: 通常为两天也可按客户要求

Voltage 电压	Testing Condition 测试条件	Duration Time 测试时间
110V	Room Temperature 室温	72 Hour
220V	Room Temperature 室温	24 Hour

- Safety Test: Leakage current test, Grounding test
安全测试工: 漏电流测试, 接地测试
- Illumination Test
照度测试

7.3 Product Safety Certificates 产品安全证书

➤ **CE, RoHS, FCC**

7.4 Product Warranty Statement 产品质保声明

LED light life span is usually about 50,000 hours, Base on following terms, Ohmax warrants Ohmax LED lamps to be free from defects in material and workmanship and to operate from the date of manufacture for the time period of 3 years.

奥马斯依据下列条款郑重承诺：LED 灯的使用寿命一般在 50,000 小时，基于以下条款，奥马斯 LED 灯提供客户三年的质保产品使用期。

Terms and Conditions:
条款和条件：

This warranty will not apply in the event of conditions demonstrating abnormal use or stress, such as operating temperatures in excess of maximum rated temperatures, under/over voltage conditions, excessive switching cycles or operating hours, dirty or broken sockets, or improper lamp installation. Replacement of LED driver board provided by Ohmax with any other product will void entire warranty.

本质保承诺当在非正常使用或因超过某些极限条件的情况下不予认可。如使用温度超过最大额定温度，低于或超过电压允许范围，插座污损造成漏电等意外情况，灯具的不正确安装。不管用任何其它产品更换奥马斯产品上的 LED 电源都不适用于本质保范围。

The user shall promptly return the product at the user's expense to Ohmax after receiving instructions as if when and where to ship product. Failure to follow this procedure shall void this warranty
客户在收到奥马斯退回产品的通知后，应在规定的时间内自费退回给奥马斯指定的地址。客户未能按照要求做到，则本质保承诺不予生效。

NO labor allowance is made for any lamp replacement during the warranty period. Any labor option or cost that is not pre-approved by Ohmax will not be eligible for reimbursement.

在质保期内任何人为的对奥马斯产品的任何配件或材料的更换，奥马斯对出现的产品质量问题不负任何赔偿责任。

Ohmax reserves the right to examine all failed lamps and reserves the right to be the sole judge as to whether any lamps are defective and covered under this warranty.

奥马斯保留对质量问题产品的检查权利，保留对产品质量事故是否符合本质保条件的唯一合法的解释权。

8.0 Product Usage Attention Items 产品使用注意事项

- The Luminaire shall be installed by a qualified electrician and wired in accordance with the latest IEE electrical regulations or the national requirements.
本产品必须交由专业人士安装，且电线必须符合最新电气标准或国家标准法规。
- Please cut off the power before installation and maintenance.
在安装和维护前，请先切断电源。
- The Luminaire shall, under no circumstance, be covered with thermal insulating mat or similar materials.
任何情况下，灯具都不能被隔热衬垫或类似的材料覆盖。
- LED product is much more durable for collision, knocking, but do not do it for longer life
LED 产品坚固耐用，但有意的碰撞、敲打对产品寿命是有影响的，应避免这种做法。
- Please consult qualified engineer if any queries about the installation occur
若有任何疑问，请向持有资格证书的工程师咨询。