



Product Specification

产 品 规 格 书

Product Name: LED Grow Light
产品名称: LED 植物灯

Product P/N: OH-GL-024
产品名称:

Product Size 产品尺寸	794x334x70mm
----------------------	--------------

Approval 客户确认	
Data 日期	

Prepared by 制作人	Checked by 审核人	Approved by 审批人
Name 姓名 王能相	Name 姓名 [Signature]	Name 姓名 [Signature]
Date 日期 2017.11.10	Date 日期 2017.11.10	Date 日期 2017.11.10
Dept. 部门 工程部	Dept. 部门 工程	Dept. 部门 工程

Updated version number 更新的版本号	B1
----------------------------------	----

正本

Ohmax (Asia) Limited

Tel: 00852-2432 2316 Fax: 00852-2436 5097

Address: Unit 4-6,12/F, Block B,Vigor Industrial Bldg.,14-20 Cheung Tat Road,Tsing Yi, N.T. Hong Kong

Shenzhen Ohmax Optoelectronic Lighting Co., Ltd.

Tel:0086-755-2845 5703 Fax: 0086-755-2752 4841

No.132,Fuxing Street,Hehua Community,Pinghu Subdistrict,Longgang District,Shenzhen,China



Product Specification

产 品 规 格 书

Product Name: LED Grow Light
产品名称: LED 植物灯

Product P/N: OH-GL-024
产品名称:

Product Size 产品尺寸	794x334x70mm
----------------------	--------------

Approval 客户确认	
Data 日期	

Prepared by 制作人	Checked by 审核人	Approved by 审批人
Name 姓名 王能松	Name 姓名	Name 姓名
Date 日期 2017-11-09	Date 日期	Date 日期
Dept. 部门 工程部	Dept. 部门	Dept. 部门

Updated version number 更新的版本号	B1
----------------------------------	----

Ohmax (Asia) Limited

Tel: 00852-2432 2316 Fax: 00852-2436 5097

Address: Unit 4-6,12/F, Block B,Vigor Industrial Bldg.,14-20 Cheung Tat Road,Tsing Yi, N.T. Hong Kong

Shenzhen Ohmax Optoelectronic Lighting Co., Ltd.

Tel:0086-755-2845 5703 Fax: 0086-755-2752 4841

No.132,Fuxing Street,Hehua Community,Pinghu Subdistrict,Longgang District,Shenzhen,China

1. **Product**
产品
 - 1.1 **Product photo**
产品图片
 - 1.2 **Product Definition**
产品定义
2. **Product features**
产品应用特色
3. **Product Properties**
产品技术参数
 - 3.1 **Product working circuit schematic diagram**
产品工作原理图
 - 3.2 **Product basic working technical data**
产品基本工作参数
 - 3.3 **PPFD Measuring Value**
光量子通量密度实测数据
 - 3.4 **Power of different color under voltage 110V & 220V**
不同电压下产品功率显示
 - 3.5 **Product photoelectrical testing data**
产品光电参数测试数据
 - 3.6 **Product illumination testing data**
产品照度测试参数
4. **Product Main Material**
产品主要材料及关键配件
 - 4.1 **Driver**
电源
 - 4.2 **LEDs**
灯珠
 - 4.3 **Heat dissipation**
散热
5. **Product Size & Package**
产品尺寸与包装
 - 5.1 **Product size illustration**
产品尺寸图示
 - 5.2 **Product packing info**
产品包装尺寸
 - 5.3 **Product packing illustration**
产品包装图示
 - 5.4 **Carton label**
纸箱标签
6. **Product Installment illustration**
产品安装图示
7. **QA & Safety Standard**
QA 及安全标准
 - 7.1 **Quality control per ISO9001 -2008 Standard**
质量控制依据 ISO9001 - 2008 标准
 - 7.2 **Quality controlling items**
质量控制项目
 - 7.3 **Product safety certificates**
产品质量安全证书
 - 7.4 **Product warranty statement**
产品质保声明
8. **Product Usage Attention Items**
产品使用注意事项

1. Product

产品

1.1 Product photo

产品图片



1.2 Product Definition

产品定义

LED grow light belongs to new generation grow and assistant grow light for plants. The big difference compared with traditional grow light, whether it is HPS or fluorescent or other kinds, that is LED grow light can provide plants special requirement for different light wavelength and light intensity in their different grow phases to maximize the satisfaction for plant light necessity

LED 植物灯为新一代的植物生长助长灯，其与传统植物生长灯的最大差别在于能根据不同植物在不同的生长过程对光波的特殊要求，量身定做提供植物需要的光波及光强，从而实现最大程度满足植物生长对光的要求

2. Product features

产品应用特色

- Improved the inner structure and product processing technology to get the better heating dissipation, better life span
内部的结构和工艺做了很大的改善，更好的散热处理， 更好的寿命
- Easy for the maintains without the requirement of some certain knowledge of electronics and electronic circuits when customers need to do the maintenance
当客户需要进行自己维护时， 客户对部分质量问题可以用换模块的方式解决， 不需要客户具体太多的电路及电子知识

3. Product Properties

产品技术参数

3.1 Product working circuit schematic diagram

产品工作原理图

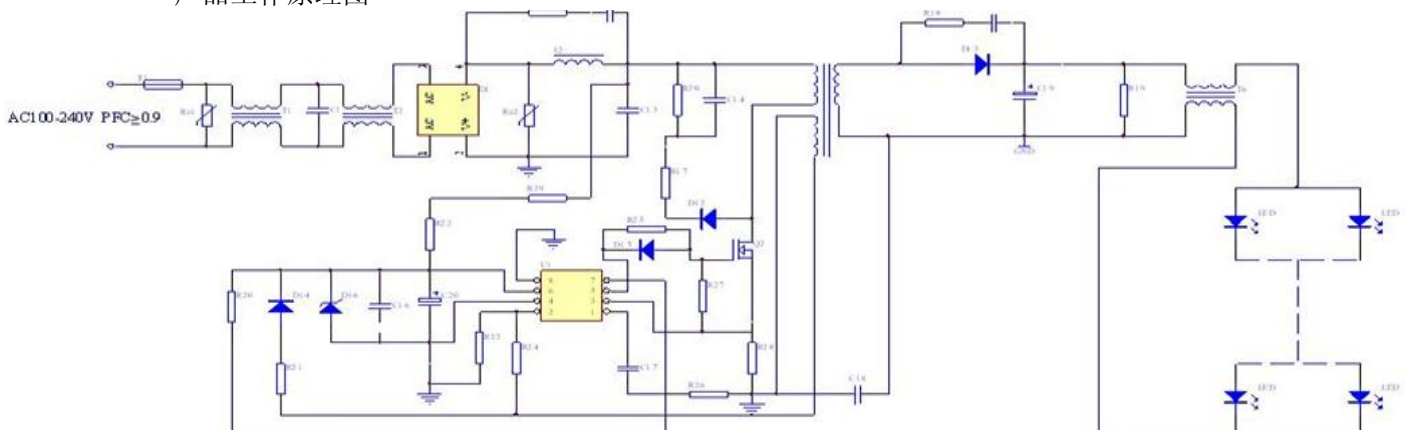

3.2 Product basic working technical data
产品基本工作参数

Power 功率	Real consumption 实际功耗	Input voltage 输入电压	Working Frequency 工作频率	LEDs 灯珠	
360*3W	698-758W	AC100-277V	50/60HZ	3W High power LEDs	
Flux 光通量	PF 功率因素	Type of LENS 灯罩	Color Ratio 光波比	Fe 幅射通量	Life Span 寿命
≥12866LM	≥0.96	钢化玻璃	Full spectrum	≥156W	50,000H
PAR W/m ²		PPFD umol/m ² · s 光量子通量密度	Main wavelength 主要波长	CCT 色温	
> 500		0.2m: Over 2000	Red:660nm Blue:440nm	2800-3200K	

3.3 PPFD Measuring Value
光量子通量密度实测数据

Length 距离	PPFD Value PPFD 值(Umol/m ² · s)
0.2M	>2000 Umol/m ² ·s
0.3M	1790 Umol/m ² ·s
0.5M	1024 Umol/m ² ·s
0.6M	795 Umol/m ² ·s
1.0M	364 Umol/m ² ·s
1.5M	190 Umol/m ² ·s
2.0M	80 Umol/m ² ·s

3.4 Power of different color under voltage 110V & 220V

110V	Power
Red color	0~418w
Blue color	0~326W
220V	Power
Red color	0~385w
Blue color	0~316W



NEW FEATURES:

This new item is 360*3W, the real consumption is only 700w, which is specially made for medicinal plant with full spectrum. It makes a switch that you can have blue Light (and 20% red) for the beginning phase (total 350w) and when the buds appear, you could turn on the second switch and 300w extra RED light will appear.

The spectrum is adjustable and the whole lamp is dimmable, that means you could adjust any color ratio you want.

3.5 Product photoelectrical testing data

产品光电参数测试数据

- Photoelectrical testing data by voltage setting 220V
输入电压为 220V 时产品的光电测试参数

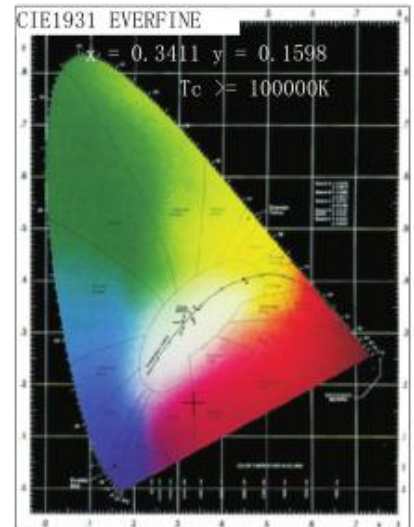
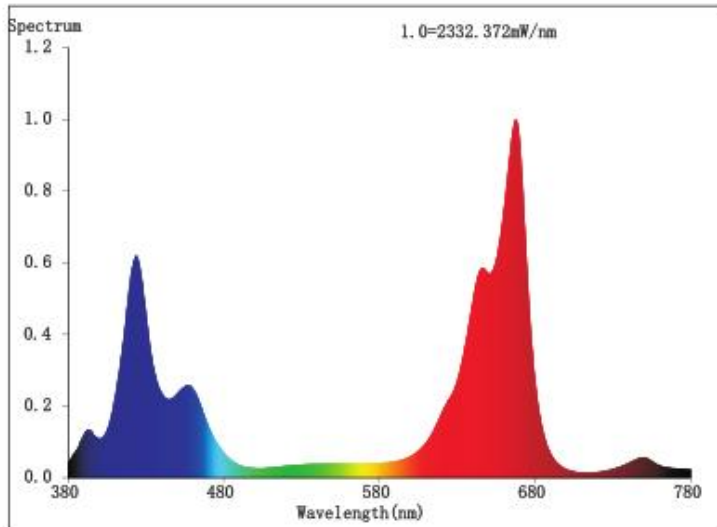

Color Parameters:

Chromaticity Coordinate: $x=0.3411$ $y=0.1598$ $u'=0.3222$ $v'=0.3396$

$T_c=100000K$ Dominant WL:Ld =610.2nm Purity=52.1%

Red Ratio:R=54.6% Peak WL:Lp=667.5nm HWL:Lhd=35.9nm

Render Index:Ra=3.8

R1 =0	R2 =0	R3 =25	R4 =0	R5 =0	R6 =0	R7 =5	
R8 =0	R9 =0	R10=0	R11=0	R12=0	R13=0	R14=41	R15=0

Photo Parameters:

Flux = 13161 lm Eff. : 18.84 lm/W Fe = 158.5 W

Electrical parameters:

V = 220.1 V I =3.349 A P = 698.6 W PF = 0.966

LEVEL:OUT WHITE:OUT

Status: Integral T = 9 ms Ip = 60280 (92%)

Test Type: Fast Test; Delicacy = Low; Tecool: ON

Model:OH-GL-024
Tester:
Temperature:23Deg
Manufactory:OHMAX

Number:
Date:2013-12-13
Humidity:60%
Remarks:220v

➤ Photoelectrical testing data by voltage setting 110V
输入电压为 110V 时产品的光电测试参数

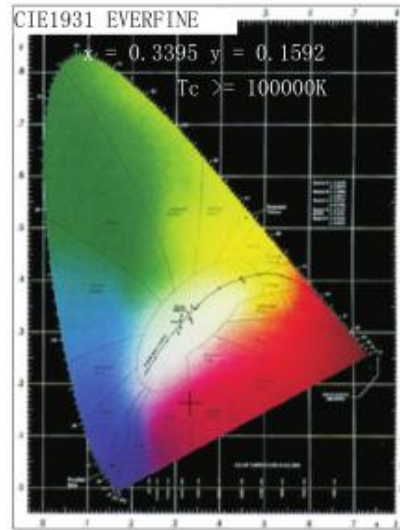
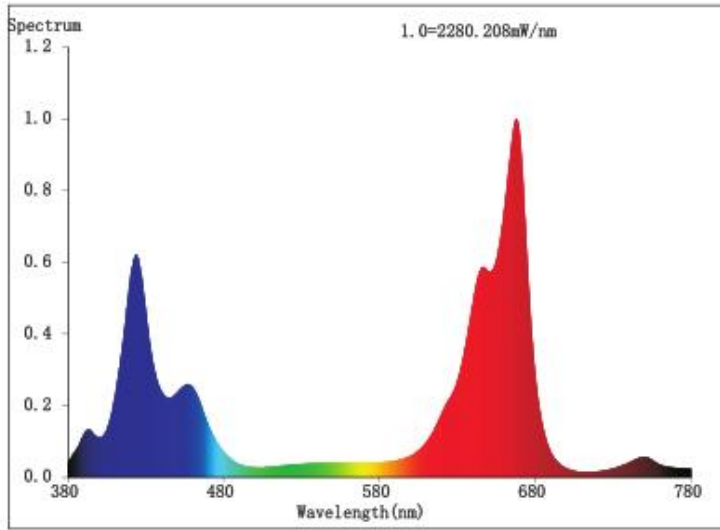

Color Parameters:

Chromaticity Coordinate: x=0.3395 y=0.1592/u'=0.3210 v'=0.3386

Tc=100000K Dominant WL:Ld =610.2nm Purity=52.3%

Red Ratio:R=54.2% Peak WL:Lp=667.9nm HWL:Lhd=36.0nm

Render Index:Ra=4.1

R1 =0	R2 =0	R3 =27	R4 =0	R5 =0	R6 =0	R7 =6		
R8 =0	R9 =0	R10=0	R11=0	R12=0	R13=0	R14=42	R15=0	

Photo Parameters:

Flux = 12866 lm Eff. :16.97 lm/W Fe = 155.7 W

Electrical parameters:

V = 111.2 V I = 6.874 A P = 758 W PF = 0.987

LEVEL:OUT WHITE:OUT

Status: Integral T = 9 ms Ip = 58865 (90%)

Test Type: Fast Test; Delicacy = Low; Tecool: ON

Model:OH-GL-024
Tester:
Temperature:23Deg
Manufactory:OHMAX

Number:
Date:2013-12-13
Humidity:60%
Remarks:110v

3.6 Product illumination testing data

产品照度测试参数

Illumination Graph
照度图

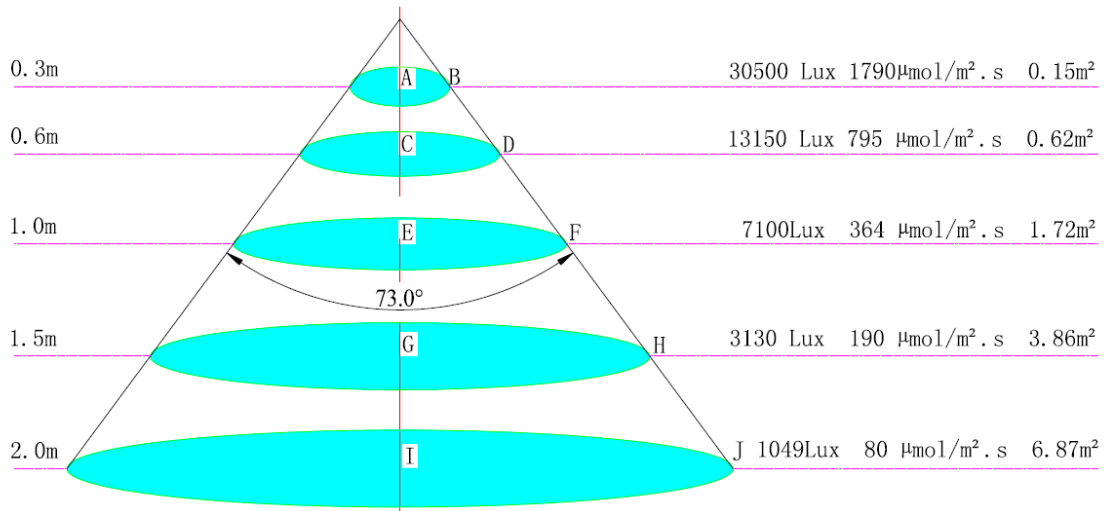

Illumination curve line graph
配光曲线图

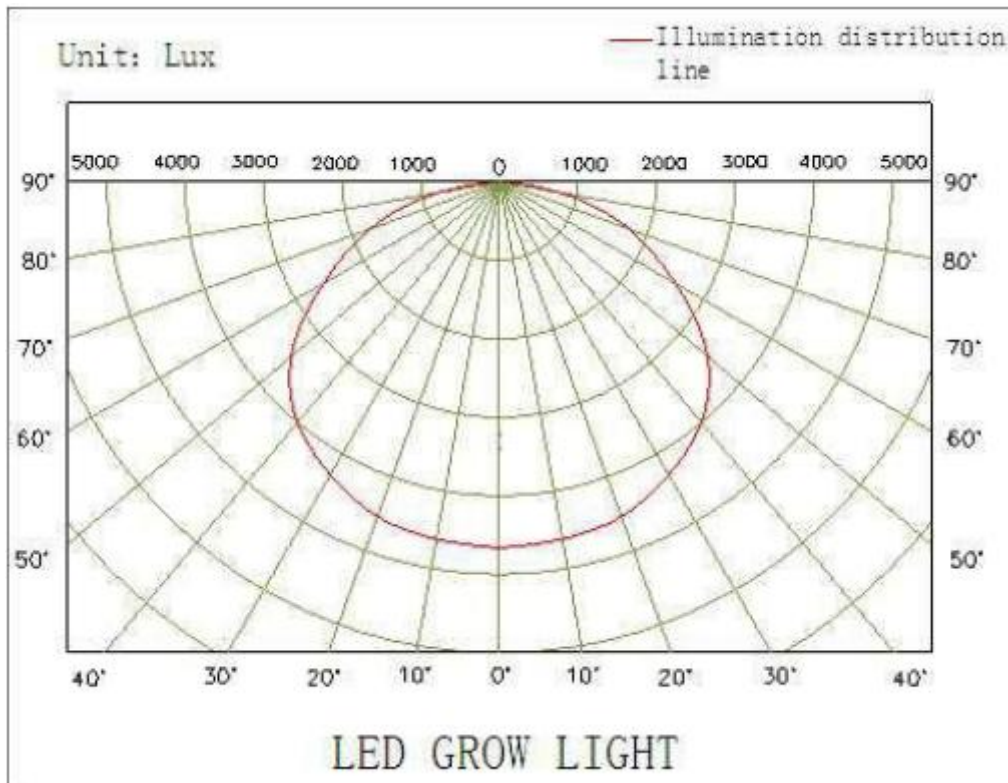

4. Product Main Material

产品主要材料及关键配件

4.1 Driver

电源

Wide voltage design, AC100V - 277V , 50/60Hz, meet all countries input voltage requirement
宽电压设计, 适合全世界各国家使用

Isolating power supply design, ensure safety in usage
隔离电源设计, 使用安全

Wide voltage design, AC100V - 277V, 50/60Hz, meet all countries input voltage requirement
宽电压设计, 适合全世界各国家使用

Isolating power supply design, ensure safety in usage
隔离电源设计, 使用安全

4.2 LEDs

灯珠

3W LEDs.low lighting attenuation, low energy consumption, strong anti-static-electricity
3W 大功率灯珠; 高亮度, 低衰减, 耗能小, 寿命长.抗静电能力强。产品符合环保无铅制程产品要求。

4.3 Heat dissipation FAN

使用风扇强制散热

High heat conductive Alum-Alloy materials
采用高导热铝合金材料

5. Product Size & Package

产品尺寸与包装

5.1 Product size illustration

产品尺寸图示

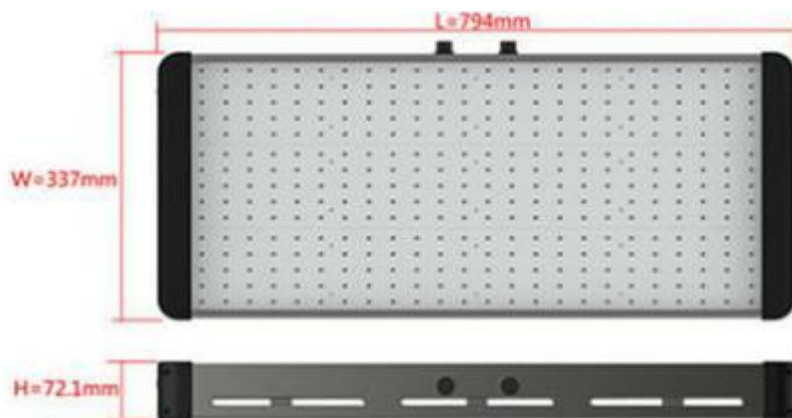

5.2 Product size illustration

产品尺寸图示

Product P/N 产品编号	Product NW 产品净重	Box Size 纸盒尺寸	Carton Size 纸箱尺寸	GW / Carton 毛重/ 箱	Qty / Carton 产品数量/ 箱
OH-GL-024	11.5kg	890*455*195mm	910*470*225mm	14.85 kg	1pcs

5.3 Product packing illustration

产品包装图示

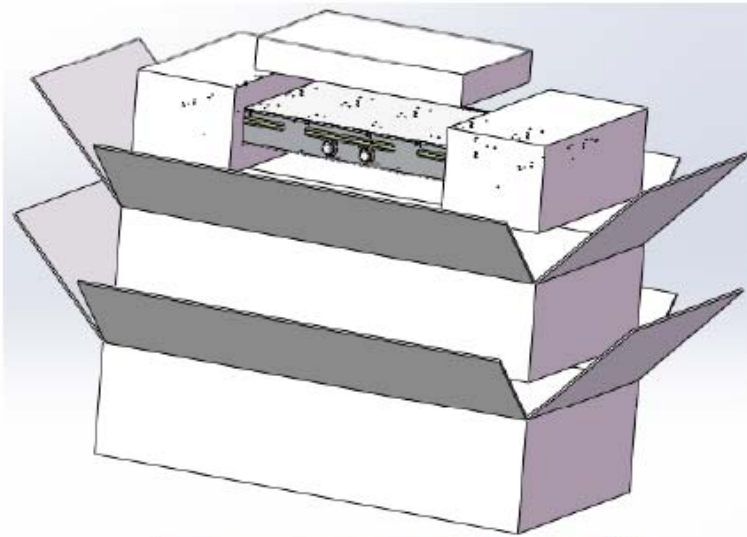

5.4 Carton label

纸箱标签



6 Product Installment illustration

产品安装图示

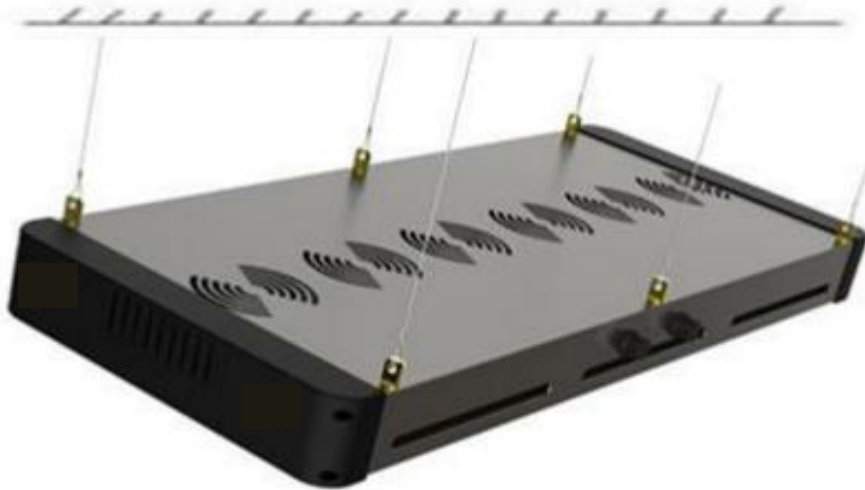

如图所示，先将LED灯上的挂线挂到挂钩上；再将挂线另一头挂到天花板或固定位置。
Use one end hook of the six Stain-less stell wire to connect the each of the lamp cut.
Then use another end hook of the six stain-less stell wire to connect the each of teh ceiling or any to fixed points .

7. QA & Safety Standard

QA 及安全标准

7.1 Quality control per ISO9001 -2008 Standard

质量控制依据 ISO9001 - 2008 标准

- **Product quality control**
产品质量控制
 - ✧ **Finish product QC inspection standard: MIL-STD-105E C=0**
产成品 QC 检验标准: MIL-STD-105E C=0
 - ✧ **Production processing QC standard: GB 2829—87 - Periodical checking and sampling**
生产过程 QC 检验标准: GB 2829-87 - 定时抽检和打样程序
 - ✧ **QC confirm every production step and keep record**
QC 记录生产的每个步骤并保留记录
- **Raw material & Components quality control**
原材料及配件质量控制
 - ✧ **Driver: Per MIL-STD-105E C=0**
驱动 依据 MIL-STD-105E C=0
 - ✧ **LEDs : Per MIL-STD-105E C=0**
灯珠 依据 MIL-STD-105E C=0
 - ✧ **Heat dissipation: Per MIL-STD-105E C=0**
散热 依据 MIL-STD-105E C=0

7.2 Quality controlling items

质量控制项目

- **Switching Test: Switch on/off for 10 times with interval time 10 sec.**
开关测试 间隔 10 秒种 10 以上开关测试
- **Reliability Tests:**
可靠性测试

	Conditions 条件
High Temperature Operation Test 高温运行测试	Ta=50°C, 240hrs
Low Temperature Operation Test 低温运行测试	Ta=-20°C, 240hrs
High Temperature Storage Test 高温存放测试	Ta=70°C, 240hrs
Low Temperature Storage Test 低温存放测试	Ta=-30°C, 240hrs
High Temperature and High Humidity Test 高温及高温测试	Ta=40°C, 95%RH, 240hrs

- **Aging Test: Default two days or Per customer requirement**
老化测试: 通常为三天也可按客户要求

Voltage 电压	Testing Condition 测试条件	Duration Time 测试时间
277V	Room Temperature 室温	72 Hour

- **Safety Test: Leakage current test, Grounding test**
安全测试工: 漏电流测试, 接地测试
- **Illumination Test**
照度测试

7.3 Product Safety Certificates

产品安全证书

- CE, RoHS, FCC ,ETL

7.4 Product Warranty Statement

产品质保声明

LED light life span is usually about 50,000 hours, Base on following terms, Ohmax warrants Ohmax LED lamps to be free from defects in material and workmanship and to operate from the date of manufacture for the time period of 3 years.

奥马斯依据下列条款郑重承诺：LED 灯的使用寿命一般在 50,000 小时，基于以下条款，奥马斯 LED 灯提供客户三年的质保产品使用期。

Terms and Conditions:

条款和条件:

This warranty will not apply in the event of conditions demonstrating abnormal use or stress, such as operating temperatures in excess of maximum rated temperatures, under/over voltage conditions, excessive switching cycles or operating hours, dirty or broken sockets, or improper lamp installation. Replacement of LED driver board provided by Ohmax with any other product will void entire warranty.

本质保承诺当在非正常使用或因超过某些极限条件的情况下不予认可。如使用温度超过最大额定温度，低于或超过电压允许范围，插座污损造成漏电等意外情况，灯具的不正确安装。不管用任何其它产品更换奥马斯产品上的 LED 电源都不适用于本质保范围。

The user shall promptly return the product at the user's expense to Ohmax after receiving instructions as if when and where to ship product. Failure to follow this procedure shall void this warranty

客户在收到奥马斯退回产品的通知后，应在规定的时间内自费退回给奥马斯指定的地址。客户未能按照要求做到，则本质保承诺不予生效。

NO labor allowance is made for any lamp replacement during the warranty period. Any labor option or cost that is not pre-approved by Ohmax will not be eligible for reimbursement.

在质保期内任何人为的对奥马斯产品的任何配件或材料的更换，奥马斯对出现的产品质量问题不负任何赔偿责任。

Ohmax reserves the right to examine all failed lamps and reserves the right to be the sole judge as to whether any lamps are defective and covered under this warranty.

奥马斯保留对质量问题产品的检查权利，保留对产品质量事故是否符合本质保条件的唯一合法的解释权。

8. Product Usage Attention Items

产品使用注意事项

- The Luminaire shall be installed by a qualified electrician and wired in accordance with the latest electrical regulations or the national requirements.
本产品必须交由专业人士安装，且电线必须符合最新电气标准或国家标准法规。
- Please cut off the power before installation and maintenance.
在安装和维护前，请先切断电源。
- The Luminaire shall, under no circumstance, be covered with thermal insulating mat or similar materials.
任何情况下，灯具都不能被隔热衬垫或类似的材料覆盖。
- LED product is much more durable for collision, knocking, but do not do it for longer life
LED 产品坚固耐用，但有意的碰撞、敲打对产品寿命是有影响的，应避免这种做法。
- Please consult qualified engineer if any queries about the installation occur
若有任何疑问，请向持有资格证书的工程师咨询。